

# PHILCO MODEL M-22 ALL-SPEED AUTOMATIC RECORD CHANGER

## INTRODUCTION

This de luxe record changer is designed to automatically play 78, 45, or 33-1/3 r. p. m. records of 7", 10", or 12" size. The changer will play twelve 7", twelve 10", or ten 12" records at one loading. It operates from a 105-125 volt, 60-cycle a-c supply. If operation is desired on a 50-cycle supply, the 50-60 cycle motor, Part No. 35-1462, must be used, with the springs supplied in the conversion kit, Part No. 40-7848.

The time interval between the last note of one record and the first note of the next one is shortened by the use of a velocity trip. The possibility of damaging the changer by holding the tone arm during a change cycle is prevented by spring-loading all actuating levers.

The controls are conveniently grouped near the front of the changer. All knobs are concentrically mounted in the front right-hand corner. The tone-arm head is immediately behind the control knobs, and the record shelf is in the front left-hand corner.

The tone arm set-down indexing is simplified by eliminating feelers and establishing the set-down by means of the record-shelf position. The nodding spindle, rather than a complicated system of levers and blades, accomplishes the record dropping. Most of the working parts are mounted on a bridge sub-assembly, a feature which makes the parts easily accessible for servicing.

## DESCRIPTION OF OPERATIONAL CYCLE

At the completion of a record, the changer trips, and allows the dog latch to engage the spur of the turntable hub gear. This rotates the cam gear, allowing the teeth of the cam gear and hub gear to engage. As the cam rotates, it forces the lifter lever down, raising the tone arm from the record. As the tone arm reaches maximum height, the tone-arm actuator, motivated by the cam gear, contacts the trip-arm stud and swings the tone arm against the rest post. After the tone arm reaches the rest post, the push-off lever rotates, nodding the spindle and dropping the next record onto the turntable. After the record has dropped, the return lever contacts the stud of the trip arm, and starts the tone arm inward. The tone arm is now controlled by the actuator and return levers, in contact with the stud of the trip arm. The return lever continues swinging the tone arm inward until it is stopped by the set-down lever, whose position is dependent upon the setting of the record shelf. This stoppage of the inward travel of the tone arm by the established position of the return lever accomplishes the set-down indexing. The tone arm is thus held above the set-down point. The lifter lever now moves upward, slowly dropping the tone



MODEL M-22

TPO-1843

arm to the record surface. As the cam gear continues to rotate, the actuator lever is moved outward and away from the trip-arm stud. The tone-arm return lever then moves away from the trip-arm stud, but the spring portion of the actuator momentarily remains in contact with the stud, eliminating a sudden release of control of the tone arm, and preventing the needle from jumping into the modulated grooves. The trip-plate supporting finger now engages the dog latch, and the index lever locks the cam gear in a neutral position. The tone arm is now free to play the record.

As the tone-arm advances toward the spindle, the friction-clutch trip finger engages the end of the trip plate. Through the applied pressure of the friction finger (approximately 2 grams) against the trip plate, the trip-plate finger supporting the dog latch begins to move, lessening the engagement of the trip-plate finger and dog latch, preparatory to releasing the latch. This engagement is slowly lessened while the needle is in the playing grooves, giving the reset cam an opportunity (once each revolution of the turntable) to reset the trip plate into full engagement and slip the friction finger in the friction clutch. As the needle rides in the lead-out or eccentric groove of the record, the velocity of the friction finger is increased. The speed of the disengagement of the trip plate supporting finger and the dog latch is also increased sufficiently to allow complete disengagement of the dog latch before it has been restored by the reset cam.

## ADJUSTMENTS

### SPINDLE ADJUSTMENT

The spindle should be checked for perpendicularity (use square on turntable surface) when the changer

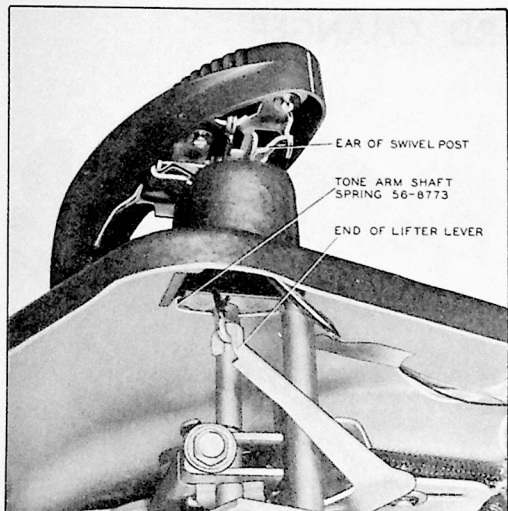

TPO-1831

Figure 1. Tone-Arm Height and Lift Adjustments and Vertical Timing Adjustment

is out of cycle. To adjust, bend the ear on the push-off-lever assembly; bending the lever toward the spindle spring throws the top of the spindle away from the record shelf. This is shown in figures 3 and 6.

### RECORD SHELF

**CAUTION:** This adjustment must be made immediately after a change cycle is completed.

With the changer set for manual operation, place a record-shelf gauge, Part No. 45-6647, on the record shelf. The edge of the gauge should fit snugly against the edge of the raised portion of the shelf, without flexing the spindle.

If the gauge does not fit properly, loosen the two saddle mounting screws holding the record shelf to the base plate (figure 2), and adjust the position of the record shelf. Then tighten the screws.

### TONE-ARM HEIGHT AND LIFT

With the changer out of cycle, and the tone arm over the base plate, the needle point should be  $1/8'' \pm 1/16''$  above the base plate. To adjust the clearance, bend the protruding ear of the swivel post, at the rear of the tone-arm heel. See figure 1. Bending the ear upward decreases the clearance, downward increases the clearance. Raise the tone arm to its maximum height, and place it against the rest post. There should be approximately  $3/32''$  clearance between the lower edge of the tone arm and the top of the rest-post hook. Bend the ear of the swivel to obtain the most satisfactory adjustment of both the rest-post clearance and the base-plate clearance.

### VERTICAL TIMING

Adjust the vertical timing by bending the end of the lifter lever (shown in figure 1), which attaches to the pull-cord, so that there is  $1/32''$  to  $1/16''$  slack in the pull-cord for all tone-arm positions between the tone-arm rest post and the spindle when the changer is out of cycle. Check by cycling the changer and noting if the lifter lever and pull-cord will raise the tone arm to its maximum height.

### SET-DOWN

Set the record shelf to the 12" position. Set the eccentric stud to its center position toward the corner of the base plate. This stud is accessible through a hole in the base plate near the tone-arm stanchion (see figure 5). Place a 7" record on the turntable, set the record shelf to the 7" position, and cycle the changer by hand until the tone arm is just above the record. Loosen the hex-head clamp screw on the trip arm (see figure 3), and swing the tone arm until the needle is  $1/8''$  in from the edge of the record. Tighten the clamp screw, and check the adjustment by putting the changer through another cycle. If the set-down point is slightly incorrect, it may be corrected by means of the eccentric stud mentioned above. Recheck the needle set-down. The trip arm should be positioned vertically so that the friction finger is midway between the base plate and the lifter lever. Remove the 7" record. Set the record shelf to the 10" position, and place a 10" record on the turntable. Rotate the turntable until the needle is just above the record. If the needle is not  $1/8''$  in from the edge of the record, an adjustment may be made by bending the ear of the set-down cam which is in contact with the eccentric stud. See figure 2. Bending the ear outward moves the set-down point away from the spindle; bending the ear in toward

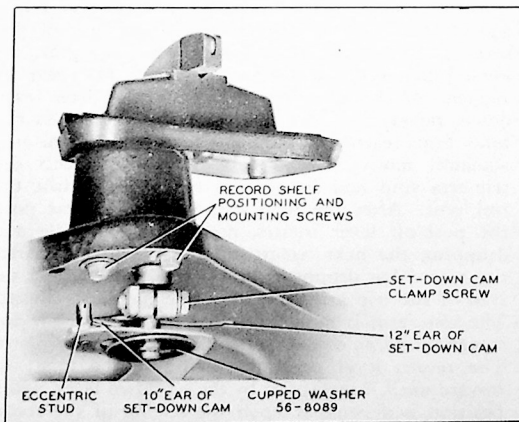

TPO-1839

Figure 2. Record-Shelf Adjustment and 10", 12", and Fine Set-down

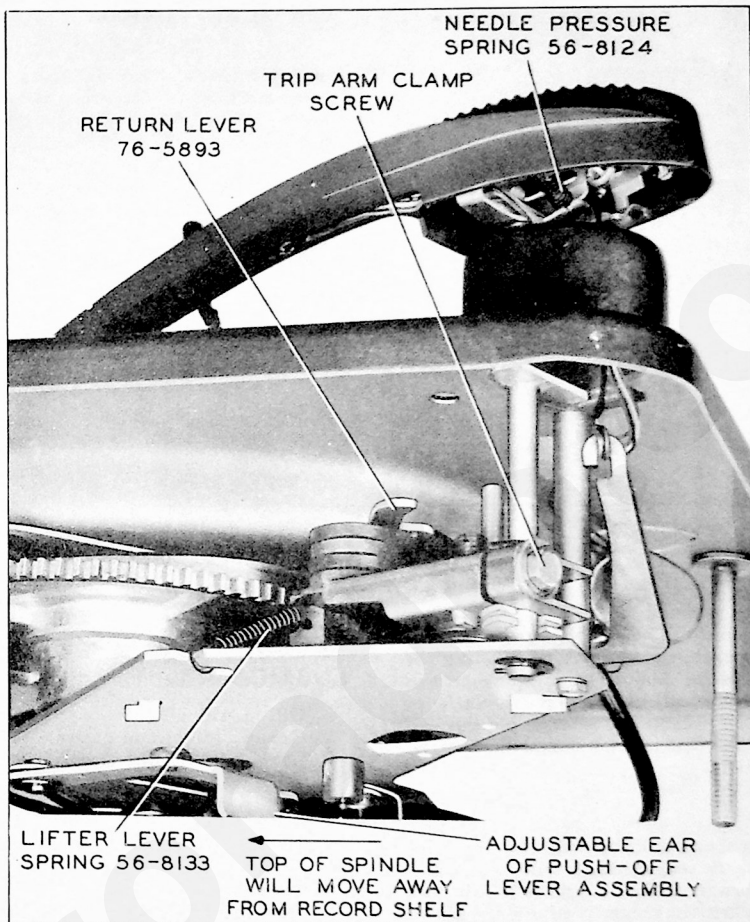

TPO-1845

Figure 3. Adjustment of Trip Arm for 7" Set-down

the shelf shaft moves the set-down point toward the spindle. Recheck the needle set-down. Using a 12" record, with the shelf set to the 12" position, repeat the adjustment, bending the corresponding ear of the set-down cam (figure 2).

The eccentric stud mentioned above (shown in figures 2 and 5) provides a fine adjustment of the set-down position. This adjustment varies the set-down position of ALL size records over a total range of  $3/16$ ". Do not use this adjustment unless it is desired to change all three set-down positions by an equal amount.

## TRIP

**CAUTION:** Do not adjust the friction clutch until the trip-plate engagement is properly set, as explained below.

The proper trip action is greatly dependent upon the proper engagement of the dog latch and the finger of the trip plate supporting it. The correct engagement is  $5/64$ " (or approximately one-half the width of the supporting finger of the trip plate) when the ear of the reset arm is contacting the peak point of the reset cam. This is shown in figure 4. The ex-

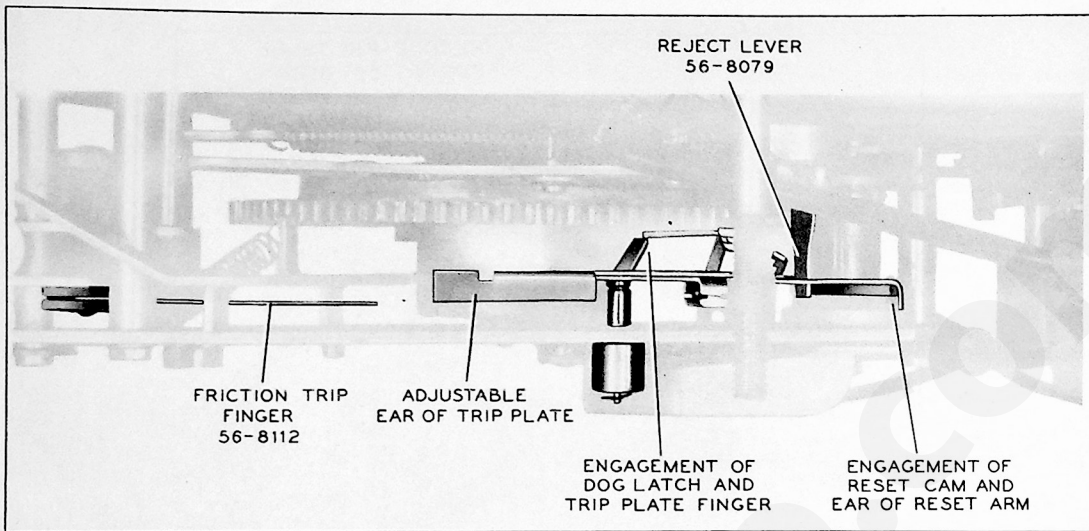

Figure 4. Trip Adjustment

TPO-1841

ment of this engagement is adjustable by bending the ear of the trip plate, shown in figure 6. Bending the ear inward decreases the amount of engagement, and bending the ear outward increases the amount of engagement. This adjustable ear is accessible through the large hole in the bridge, and should be bent by using long-nose pliers.

**NOTE:** Too much engagement will prevent tripping, while too little engagement will cause pre-tripping. If the changer is Run 2, and if it still does not trip after the trip is properly adjusted, remove the tone-arm-shaft spring.

After the trip-latch engagement is set, check the changer for proper trip action. If the trip action is faulty, i.e., if the changer pre-trips or does not trip at all, recheck the trip-latch adjustment. If the changer still does not operate properly, check for tight tone-arm lead dress or excessive friction in the tone-arm-shaft bearing. If this does not clear the trouble, the friction clutch can be adjusted, although this should *not* normally be necessary. This is a screw adjustment and is accessible, when the tone arm is on the rest post, through a hole in the base plate near the tone-arm stanchion (see figure 5). Turn the screw counterclockwise until the clutch is just snug (do not tighten), then loosen one turn. Check the adjustment by playing several records. If the changer pre-trips, loosen the screw (turn clockwise) a bit more. This trip arm and clutch assembly is shown in figure 16.

## LUBRICATION

### LUBRICANTS

Oil: S.A.E. 20.  
Grease: Motor cup grease.  
Contact lubricant: Dow Corning "DC-4."

### PARTS NOT TO BE LUBRICATED

- Motor drive shaft.
- Motor pulley.
- Drive belt.
- Idler tire.
- Dog latch (on cam gear).
- Lifting lever (where dog rides).
- Trip-plate assembly.
- Friction finger.
- Friction washer.
- Spindle latch (may be lubricated with powdered graphite or talcum powder).

### PARTS TO BE GREASED

#### Actuators

1. Lifting lever, where lever contacts cam gear.
2. Tone-arm-actuator lever where it contacts stud of friction-clutch assembly.

#### Base Plate

1. Switch lever where it slides on base plate, and slot where ear rides.
2. Motor-speed-shift plate, where it rides in guide slots, and slot that rides on cam-gear spindle; control links where they ride on base plate.

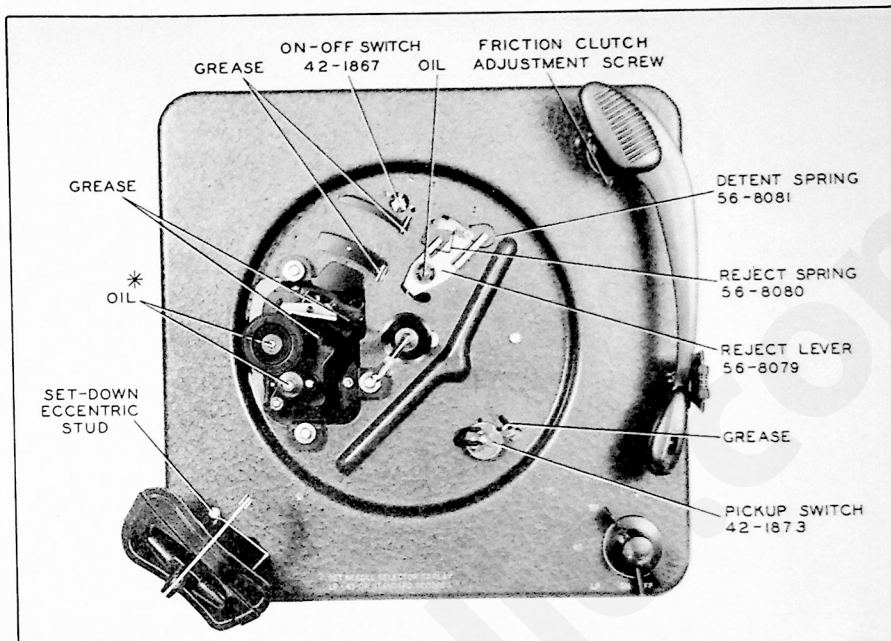

TPO-1838

Figure 5. Top View, Showing Lubrication Points

### Bridge Assembly

Push-off lever where end slides on bridge, where stud rides in slot of bridge, and at pivot pin.

### Cam Gear

All cam surfaces and gear teeth except dog latch.

### Friction-Clutch Assembly

Stud of friction-clutch assembly where return lever and tone-arm actuator ride.

### Motor

NOTE: When lubricating the motor, use grease or oil very sparingly. Excessive lubrication will cause erratic operation.

1. Cam surfaces of idler-wheel lifter.
2. Detent surfaces.
3. Guide slots of shifter plate.
4. Extension of idler shaft in contact with lower shifter plate.
5. Retaining ear of speed-shift lever.

### Record Shelf

1. Record-shelf-shaft bearing.
2. Detents for record shelf.
3. Hold-down pin and detents.
4. Hold-down shaft.
5. Set-down cam, where eccentric stud rides.

### PARTS TO BE OILED

1. Cam-gear spindle.
2. Control-knob shaft.
3. Index-lever roller.
4. Motor.
  - a. Idler-assembly pivot shaft.
  - b. Idler-wheel shaft.
  - c. Slider bar, four points.
  - d. Two shift roller pins.
  - e. Pulley shaft (wipe dry and apply only one drop).
  - f. Under pivot bushing of shifter plate.
5. Reject-lever pivot.
6. Tone-arm shaft where it rotates in bridge.
7. Tone-arm-pivot pin where it goes through holes in base plate.
8. Trip-plate-assembly pivot in bushing only.
9. Turntable bearings, top and bottom.
10. Actuator spindle.
11. Bearing surfaces between actuator lever, washer, set-down lever, index lever, washer, and return lever (grease end of return lever where it contacts stud of friction-clutch assembly).

CAUTION: When lubricating the motor, remove the rubber belt and idler wheel. When lubrication is completed, be sure the motor shaft and pulley are free from oil and grease. Failure to observe this precaution may result in slippage.

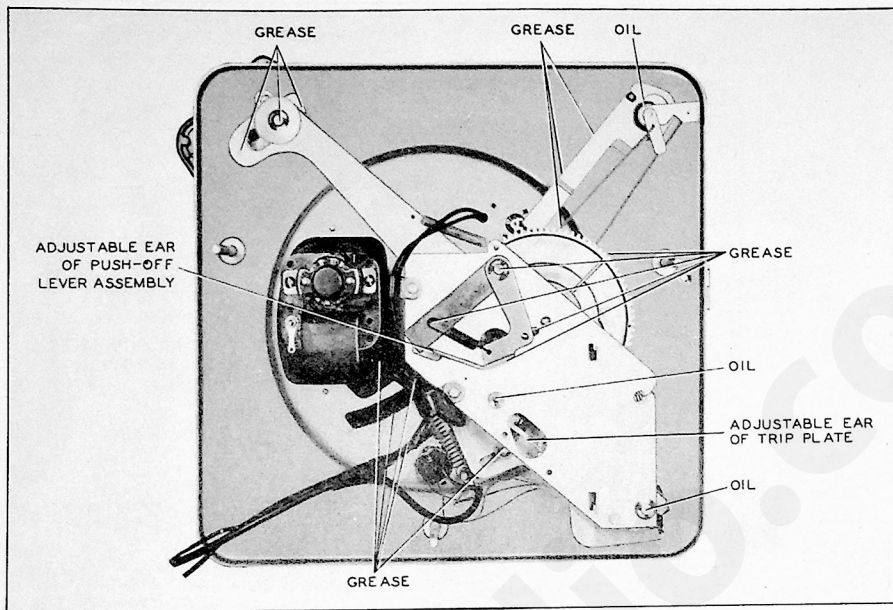

TPO-1836

Figure 6. Bottom View. Showing Lubrication Points

### CONTACT LUBRICATION

Apply Dow Corning "DC-4" to the contacts of the

cartridge contact plate, and to the dimple of the cartridge retaining spring.

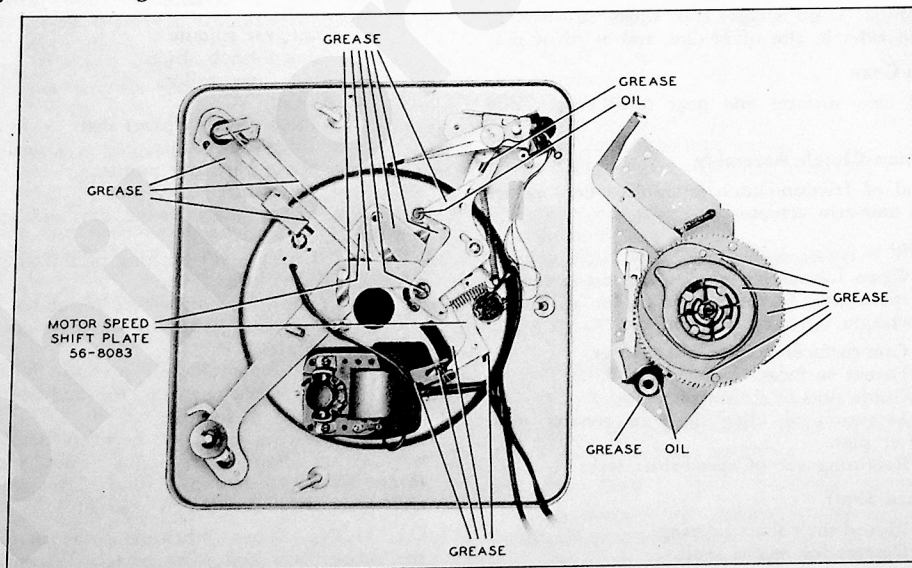

TPO-1837

Figure 7. Bottom View. Bridge Removed. Showing Lubrication Points

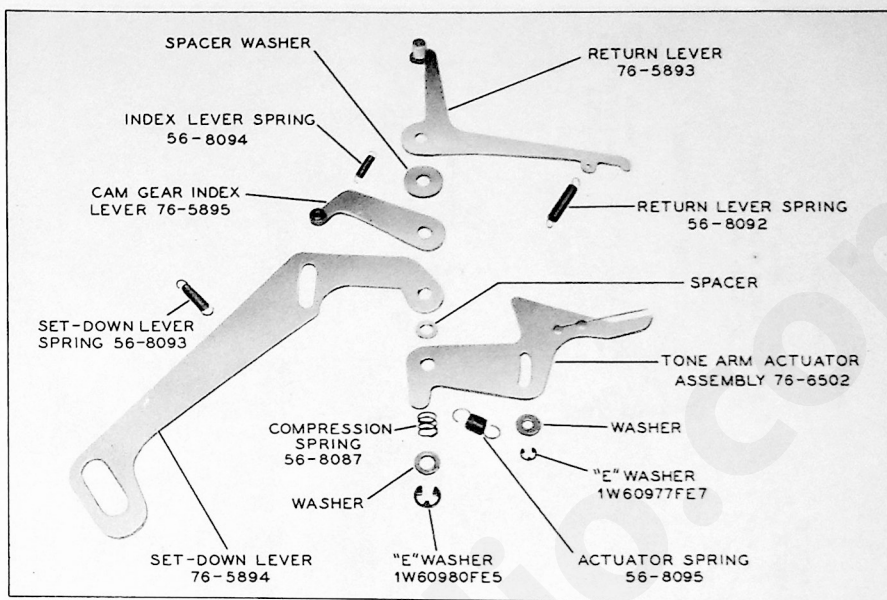

Figure 8. Actuator Assembly

TPO-1833A

## UNEVEN TURNTABLE SPEED (WOWS)

Uneven turntable speed may be caused by any of the following conditions:

1. Dirt under and around the idler-wheel assembly.
2. Idler-wheel spring loose or missing.
3. Flat spot on idler-wheel tire or turntable.
4. Loose, worn, or distorted pulley belt.
5. Oil or grease on idler-wheel tire, pulley, pulley belt, or drive shaft.
6. Speed-control knob not in proper position.

## REPLACEMENT OF PARTS AND ASSEMBLIES

The following procedures are recommended for the correct removal of parts and assemblies. The parts should be replaced by reversing the order of removal. Adjustments should be made according to the directions given in the ADJUSTMENTS section of the manual.

### 1. Crystal Cartridge

Grasp crystal cartridge with fingernails. With the other hand, hold tone arm and apply slight pressure on switch lever. Pull cartridge down and to the outside. Replace cartridge by holding contacts toward spindle, and pushing upward until firmly seated.

### 2. Needle

Remove crystal cartridge (see paragraph 1). Lift needle out gently with prying motion, using fingernail or knife point. When replacing needle, align key of needle shaft with keyway in chuck of cartridge, then push needle into cartridge.

### 3. Turntable

Remove spring retainer and washer from top of spindle bushing. Lift turntable off.

NOTE: When replacing turntable, position speed-control knob midway between LP and 45 or 45 and SP. This holds the idler wheel in a retracted position. Then replace turntable. This method will prevent damage to the idler-wheel tire.

### 4. Spindle

Disengage spindle spring. Remove spindle. Do not lose spring washer under spindle lever.

### 5. Bridge (See figure 9)

- a. Remove set-down-lever spring.
- b. Remove lifter-lever spring.
- c. Remove the three hex-head drive screws and the two plastic cable retainers.
- d. Remove "E" washer from tone-arm spindle.
- e. Remove hex-head drive screw from cam-gear spindle. This screw is located on the top.
- f. Remove pull-cord and disconnect tone-arm wires.

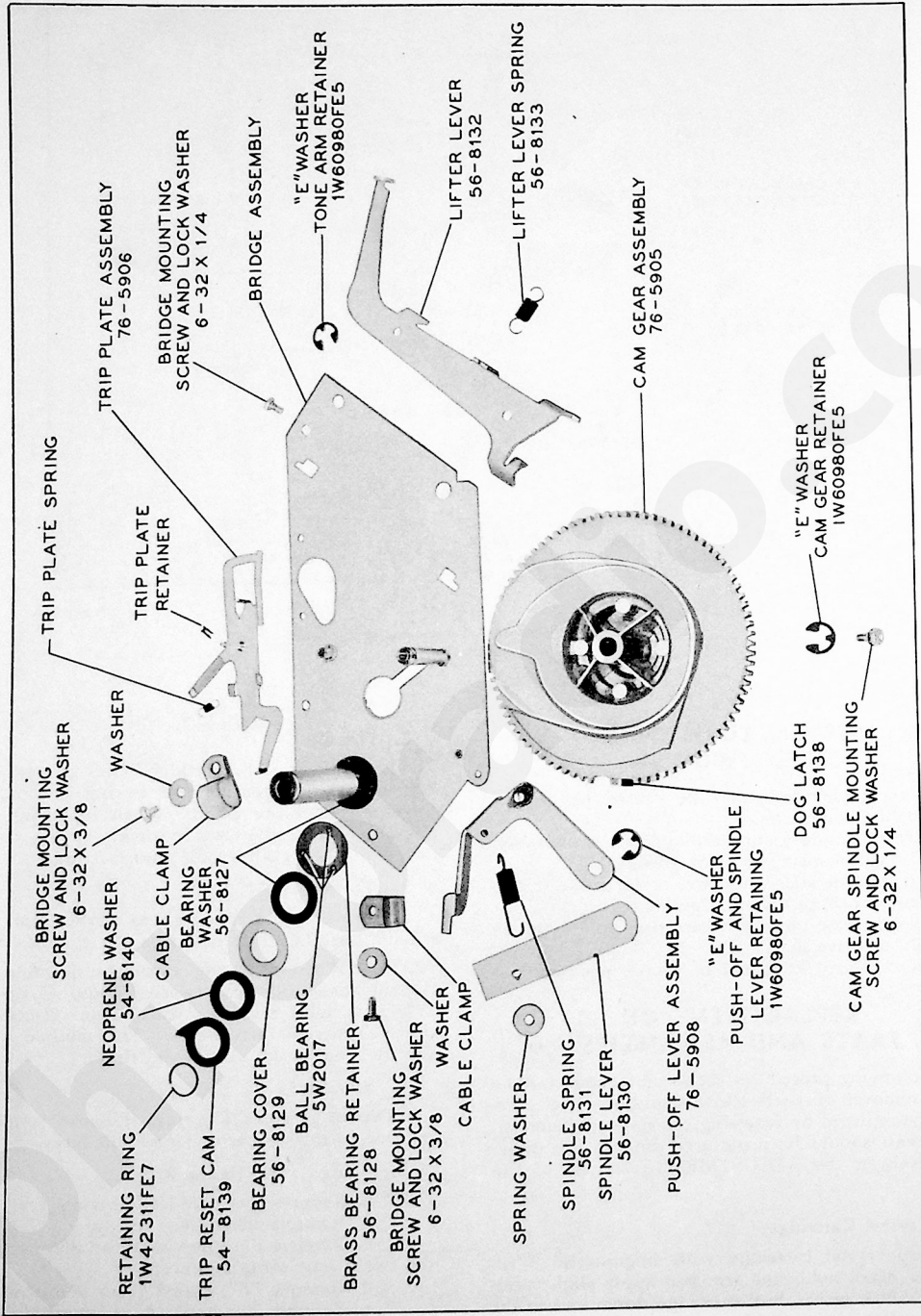

TPO-1844

Figure 9. Bridge Assembly



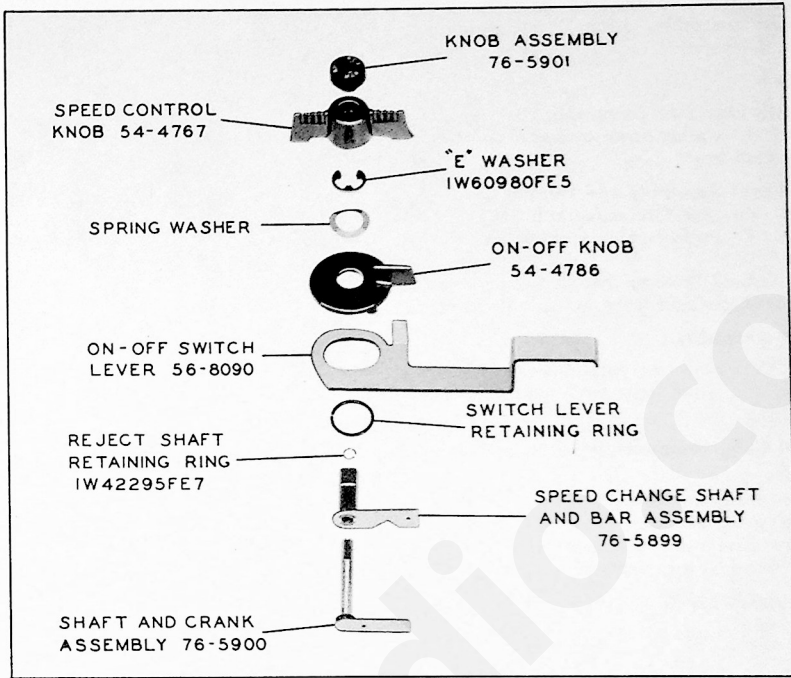

Figure 10 Control Assembly

TPO-1834

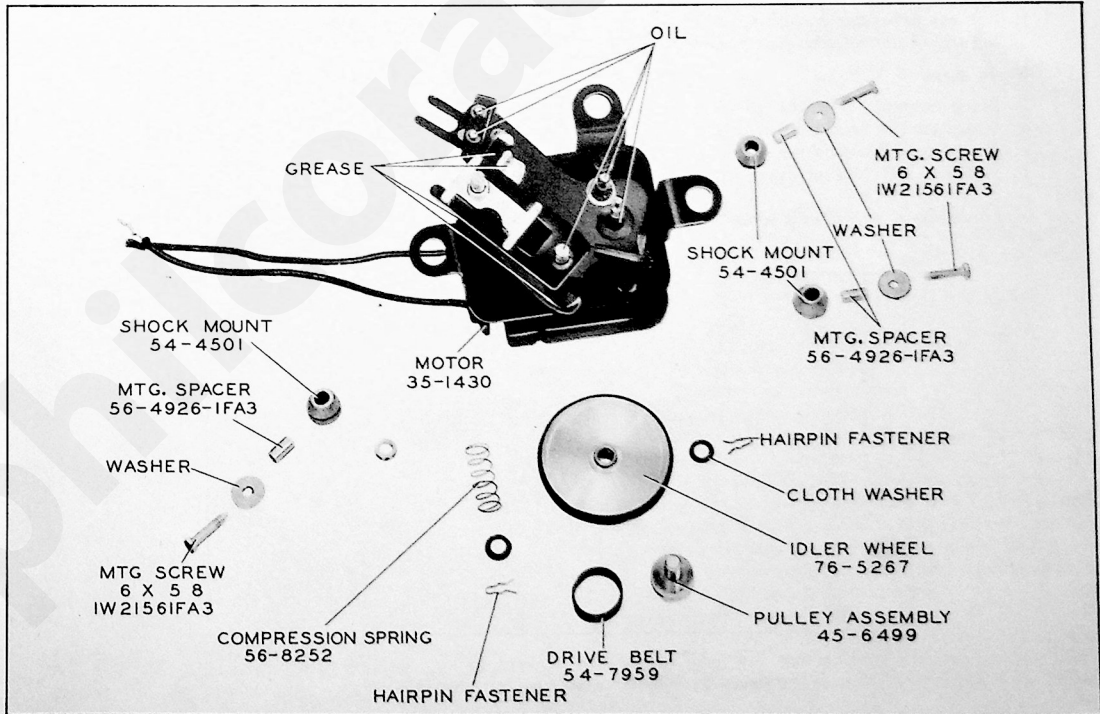

Figure 11. Motor Assembly—Part No. 35-1451

TP9-204

g. Carefully lift off bridge, cam gear, spindle bushing, trip-plate assembly, lifter lever, spindle lever, and push-off lever.

**6. Cam Gear**

- a. Remove bridge (see paragraph 5).
- b. Remove "E" washer from cam-gear spindle.
- c. Lift off cam gear.

**7. Push-off Lever Assembly and Spindle Lever**

- a. Remove cam gear (see paragraph 6).
- b. Remove "E" washer from push-off fulcrum stud.
- c. Rotate push-off lever so that stud is in large hole, and lift off both push-off lever and spindle lever.

**8. Trip-Plate Assembly**

- a. Remove cam gear (see paragraph 6).
- b. Remove clip from trip stud, and lift assembly from bushing.

**9. Trip Reset Cam, Neoprene Washer, and Ball Bearing**

- a. Remove cam gear (see paragraph 6).
- b. Remove spring retaining ring.
- c. The trip reset cam, neoprene washer, ball cover, balls, and race may be removed in that order.

**10. Trip-Arm Assembly**

- a. Remove "E" washer from end of tone-arm shaft.
  - b. Disengage pull-cord.
  - c. Loosen trip-arm-clamp screw.
  - d. Raise tone arm sufficiently to clear trip arm.
  - e. Remove trip-arm assembly.
- Figure 16 shows trip-arm assembly.

**11. Tone Arm**

- a. Place control in MAN. position.
- b. Unsolder the four tone-arm leads.
- c. Remove pull-cord from lifter lever.
- d. Remove "E" washer from end of tone-arm stud.
- e. Loosen trip-arm clamp screw.

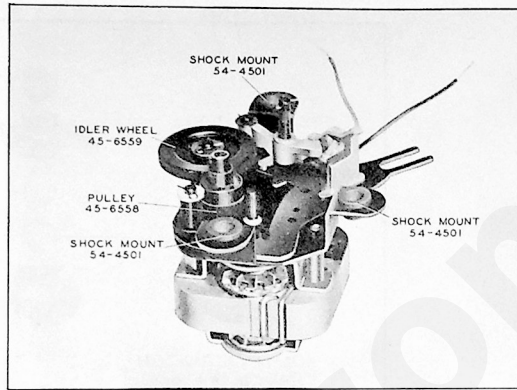

TP9-456

Figure 12. Motor Assembly—Part No. 35-1452

- f. Remove tone-arm-shaft spring, if present.
- g. Lift out tone arm.

Figure 15 shows tone-arm assembly.

**12. Motor Assembly**

- a. Remove turntable (see paragraph 3).
- b. Unsolder motor lead from switch on base plate, and free other lead from tape and spaghetti.
- c. Remove the three hex-head drive screws, washers, and spacers from motor frame.
- d. Slide jaws of speed-shift lever free of rubber grommet and ear of motor-speed-shift plate.
- e. Lift motor out.

Figures 11, 12 and 13 show motor assembly.

**13. Control Shafts and Links**

- a. Pull off MAN.—AUT.—REJ. button.
- b. Lift off speed-control knob.
- c. Remove "E" washer and spring washer.
- d. Lift off ON-OFF knob.
- e. Remove retaining ring from reject shaft.

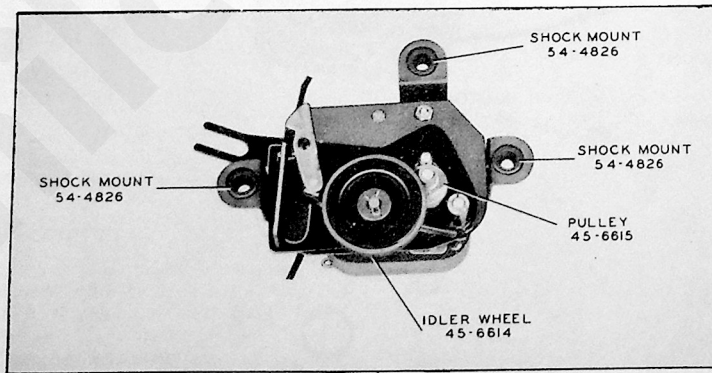

TPO-1832

Figure 13. Motor Assembly—Part No. 35-1455

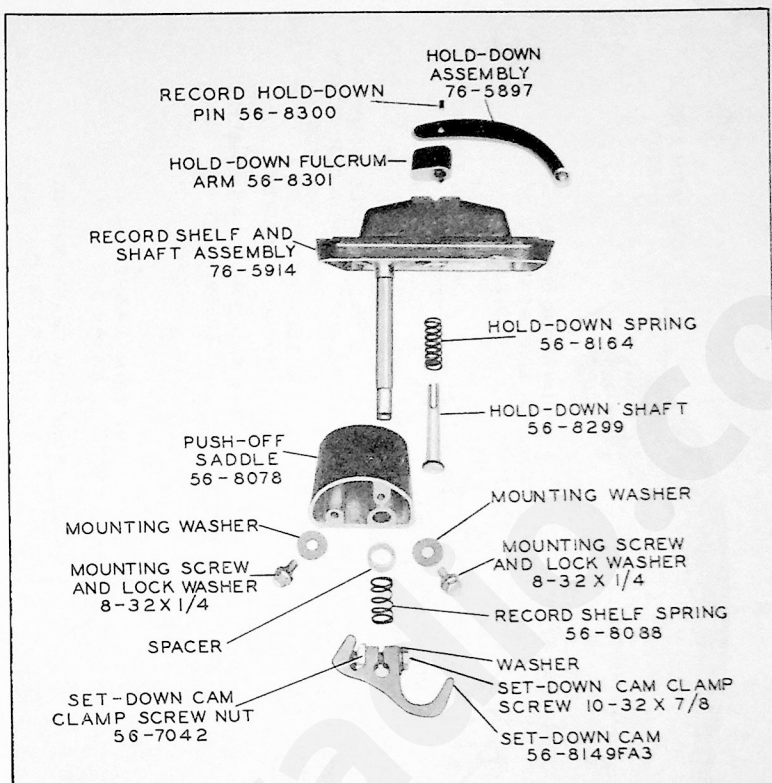

TPO-1835

Figure 14. Record-Shelf Assembly

f. From underside, pull out speed-change shaft and bar assembly and MAN.—AUT.—REJ. shaft and crank assembly.

g. Disengage each of the above from its respective links.

h. Remove speed-change link.

i. Remove heavy spring ring from control bushing.

j. Remove ON-OFF switch lever by lifting over bushing, pulling toward corner of base plate, and lifting ear out of slot.

Figure 10 shows control assembly.

#### 14. Record Shelf

a. Remove "E" washer from bottom of record-shelf shaft.

b. Remove cupped washer.

c. Loosen set-down clamp screw.

d. Remove set-down cam, record-shelf spring, and spacer (if used; Run 4 on). When reassembling, add spacer and new spring.

e. Lift record shelf from saddle.

Figure 14 shows record-shelf assembly.

#### 15. Actuator Levers

a. Remove bridge (see paragraph 5).

b. Remove spring from tone-arm return lever.

c. Remove "E" washer, washer, and compression spring from actuator stud.

d. Remove "E" washer and washer from return-lever support stud.

e. Remove tone-arm-actuator lever.

f. Remove spacer washer.

g. Remove set-down lever.

h. Remove cam-gear index lever.

i. Remove motor-speed-shift plate by pulling speed-shift lever toward center of changer, freeing grommet from jaws of lever, and returning lever to an outward position. Lift and turn free end of speed-shift plate toward tone arm; this will free ear in large slot. With free end, carefully twist plate down between return-lever support stud and spring-anchor stud. Ear in small slot will come free.

j. Remove large washer.

k. From top of base plate, remove reject and detent springs, "E" washer, and spring washer. Free reject lever of stud, and remove reject link from lever.

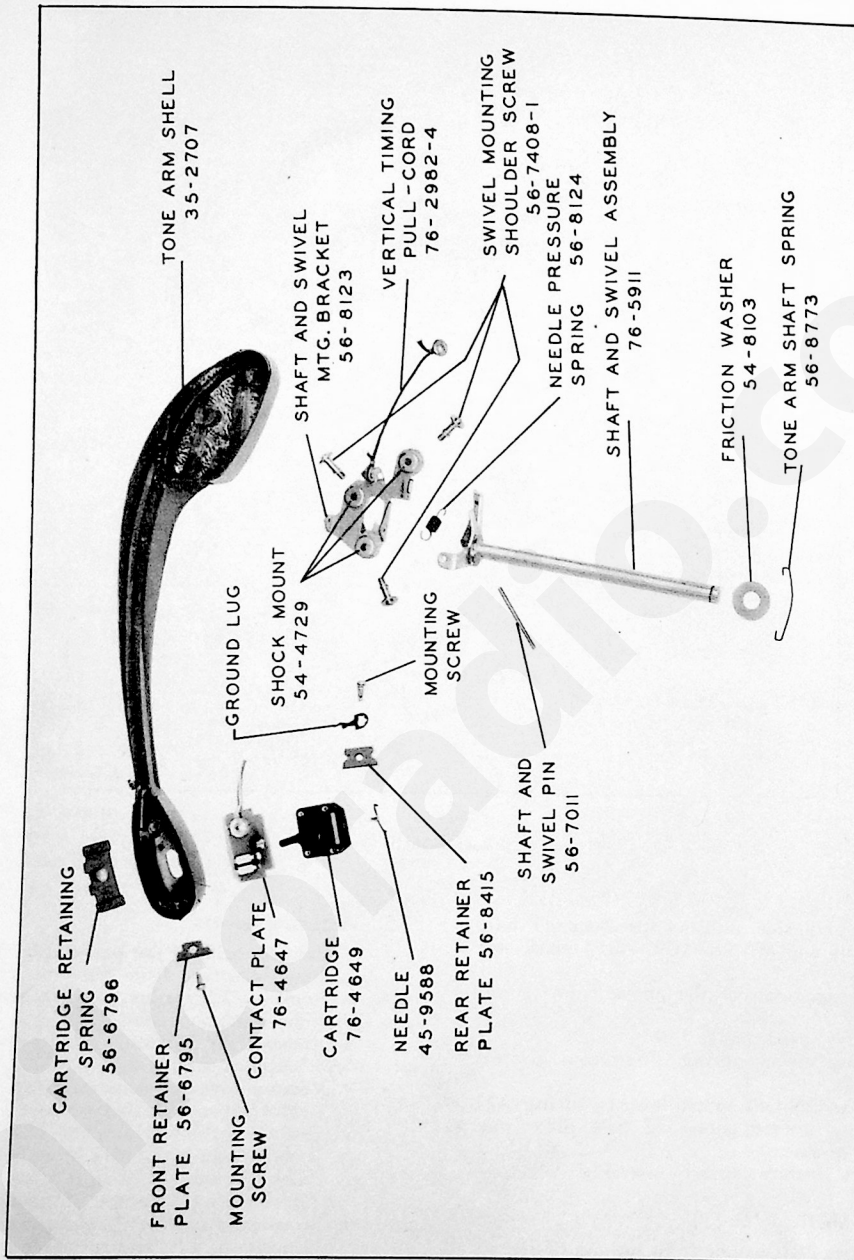

Figure 15. Tone-Arm Assembly

TPO-1840

1. Remove tone-arm-return lever. Figure 8 shows actuator assembly.

NOTE: When replacing the index-lever spring, the

tone-arm-actuator spring, and the return-lever spring, re-cement the ends to the spring mounting stud, using glyptol, as in production. This will prevent the springs from coming loose due to shock.

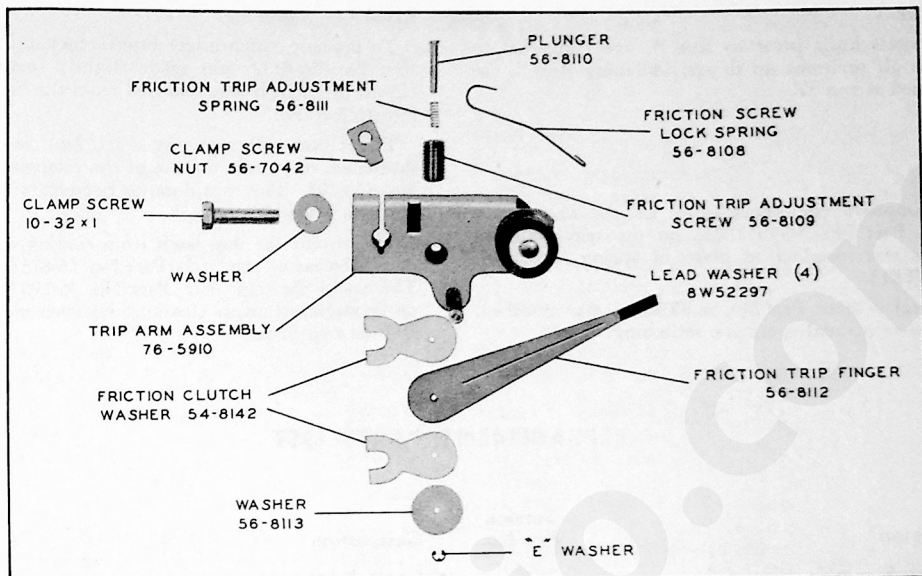

TPO-1842

Figure 16. Trip-Arm Assembly

**PRODUCTION CHANGES**

**RUN 2**

Tone-arm-shaft spring, Part No. 56-8773, was added, to stabilize tone-arm skip.

**RUN 3**

Tone-arm-shaft spring was removed, to eliminate mistracking. The inside of the tone-arm head was given an aquadag coating, to eliminate hum pick-up.

**RUN 4**

An extrusion was added to the tone-arm-shaft bearing of the tone-arm stanchion. Tone-arm-shaft spring, Part No. 56-8773, was added, to stabilize horizontal friction.

**RUN 5**

Record-shelf spacer, Part No. 56-8833, was added, to prevent jamming of shelf due to mishandling.

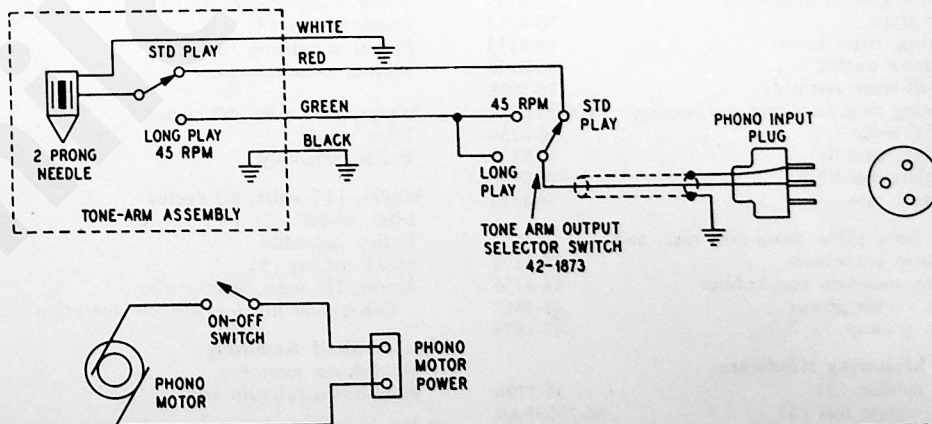

TPO-2313

Figure 17. Wiring Diagram of Model M-22

**RUN 5Z**

Changers built prior to Run 5, and converted to include all revisions up to and including Run 5, are identified as run 5Z.

**RUN 6**

To improve the performance of the changer, a spring, Part No. 56-9012FCP, on the trip plate assembly, was installed in place of spring, Part No. 56-8117FE15.

The reject lever, Part No. 56-8079FA3, was modified, to improve manual-automatic switching.

**RUN 7**

To prevent clutch finger interference, the lift lever, Part No. 56-8132, was made slightly smaller. One-eighth of an inch was removed from the bent ear, for finger clearance.

The clutch plunger pin, Part No. 56-8110, was shortened, to permit the use of the retainer ring, Part No. 56-8793. This was done to prevent failure of the trip-arm assembly.

To prevent the dog latch from coming off in shipment, the ear of the latch, Part No. 56-8138, was bent. The ear of the trip plate, Part No. 76-5907-1, was cut on an angle, to insure clearance between the dog latch and the trip plate.

**REPLACEMENT PARTS LIST**

| Description  | Service Part No. |
|--|------------------|
| <b>Actuator Assembly (figure 8)</b>                              |                  |
| Cam-gear index lever   | 76-5895          |
| Spring, index lever  | 56-8094          |
| Compression spring   | 56-8087          |
| Return lever   | 76-5893          |
| Spring, return lever   | 56-8092          |
| Set-down lever   | 76-5894          |
| Spring, set-down lever   | 56-8093          |
| Tone-arm-actuator assembly                                       | 76-6502          |
| Spring, actuator   | 56-8095          |
| <b>Bridge Assembly</b>   |                  |
| Ball bearing, 1/8" dia. (3)                                      | 5W2017           |
| Bearing cover  | 56-8129          |
| Bearing retainer, brass  | 56-8128          |
| Bearing washer (2)   | 56-8127          |
| Cam-gear assembly  | 76-5905          |
| Dog latch  | 56-8138          |
| Pin, dog-latch mounting  | 56-8139          |
| Lifter lever   | 56-8132          |
| Spring, lifter lever   | 56-8133          |
| Neoprene washer  | 54-8140          |
| Push-off-lever assembly  | 76-5908          |
| Retaining ring, reset cam and bearing                            | 1W42311FE7       |
| Spindle lever  | 56-8130          |
| Spring, spindle  | 56-8131          |
| Trip-plate assembly  | 76-5906          |
| Trip-reset cam   | 54-8139          |
| <b>Changer base plate, tone-arm rest, and tone-arm stanchion</b> |                  |
| Bumper, tone-arm rest, rubber                                    | 76-5892          |
| Switch, motor power  | 54-8136          |
| Switch, pickup   | 42-1867          |
| Switch, pickup   | 42-1873          |
| <b>Changer Mounting Hardware</b>                                 |                  |
| Sleeve, rubber (3)   | 54-7798          |
| Spring, heavy, top (3)   | 56-7059FA9       |
| Spring, light, bottom (3)  | 56-7059-1FJ47    |
| Speed nut (3)  | W-2554           |

| Description   | Service Part No. |
|---|------------------|
| <b>Control Assembly</b>   |                  |
| Knob assembly, MAN.—AUT.—REJ.   | 76-5901          |
| Knob, ON-OFF  | 54-4786          |
| Knob, speed control   | 54-4787          |
| Lever, ON-OFF switch  | 56-8090          |
| Link, reject  | 56-8084          |
| Link, speed change  | 56-8091          |
| Retaining ring, reject shaft  | 1W42295FE7       |
| Retaining ring, switch lever  | not carried      |
| Shaft-and-bar assembly, speed change  | 76-5899          |
| Shaft-and-crank assembly, reject  | 76-5900          |
| <b>Motor, 117 volts, 60 cycles</b>  |                  |
| Drive belt  | 35-1451          |
| Grommet, rubber, speed-selector lever   | 54-7959          |
| Idler wheel   | 27-4707          |
| Plate, motor speed shift  | 76-5267          |
| Pulley assembly   | 56-8083          |
| Screw, motor mounting (3)   | 45-6499          |
| Shock mount (3)   | 1W21561FA3       |
| Spacer, mounting (3)  | 54-4501          |
| Spring, idler retractor   | 56-4926-1FA3     |
| <b>Motor, 117 volts, 60 cycles</b>  |                  |
| Idler wheel   | 35-1452          |
| Pulley assembly   | 45-6559          |
| <b>Motor, 117 volts, 60 cycles</b>  |                  |
| Idler wheel   | 45-6558          |
| Pulley assembly   | 35-1455          |
| Shock mount (3)   | 45-6614          |
| Motor, 117 volts, 50-60 cycles  | 45-6615          |
| Conversion kit, for 50-cycle operation  | 54-4826          |
|   | 35-1462          |
|   | 40-7848          |
| <b>Record-Shelf Assembly</b>  |                  |
| Hold-down assembly  | 76-5897          |
| Hold-down fulcrum arm   | 56-8301          |
| * This motor not carried in stock. Order motor Part No. 35-1451. If motor Part No. 35-1455 is replaced by motor Part No. 35-1451, order three shock mounts, Part No. 54-4501. |                  |

## REPLACEMENT PARTS LIST (Cont.)

| Description                            | Service Part No. | Description                           | Service Part No. |
|--|------------------|---------------------------------------|------------------|
| Hold-down pin                          | 56-8300          | Retainer plate, front                 | 56-6795          |
| Hold-down shaft                        | 56-8299          | Retainer plate, rear                  | 56-8415          |
| Hold-down spring                       | 56-8164          | Screw, shoulder, bracket mounting (3) | 56-7408-1        |
| Push-off saddle                        | 56-8078          | Shaft-and-swivel assembly             | 76-5911          |
| Record-shelf and shaft assembly        | 76-5914          | Shock-mount, bracket mounting (3)     | 54-4729          |
| Set-down cam                           | 56-8149FA3       | Spring, cartridge retaining           | 56-6796          |
| Nut, cam locking                       | 56-7042          | Spring, needle pressure               | 56-8124          |
| Spacer                                 | not carried      | Spring, tone-arm shaft                | 56-8773          |
| Spring, record shelf                   | 56-8088          | Tone-arm shell                        | 35-2707          |
| Washer, cupped                         | 56-8089          | Washer, horizontal friction (plastic) | 54-8103          |
| <b>Reject lever</b>                    | 56-8079          | <b>Trip-arm assembly</b>              | 76-5910          |
| Spring, detent                         | 56-8081          | Finger, friction trip                 | 56-8112          |
| Spring, reject                         | 56-8080          | Nut, clamp screw                      | 56-7042          |
| <b>Spindle</b>                         | 76-5909          | Plunger                               | 56-8110          |
| <b>Tone-arm assembly (complete)</b>    | 35-2710          | Screw, friction-trip adjustment       | 56-8109          |
| Bracket, mounting for shaft and swivel | 56-8123          | Spring, friction screw lock           | 56-8108          |
| Cartridge (includes needle)            | 76-4649          | Spring, friction-trip adjustment      | 56-8111          |
| Contact plate                          | 76-4647          | Washer                                | 56-8113          |
| Needle                                 | 45-9588          | Washer, friction clutch (plastic) (2) | 54-8142          |
| Needle, sapphire tips                  | 45-9589          | Washer, lead (4)                      | 8W52297          |
| Pin, shaft and swivel                  | 56-7011          | <b>Turntable</b>                      | 35-2711          |
| Pull-cord, vertical timing             | 76-2982-4        | Retainer, turntable                   | 56-8097          |
|  |                  | Washer, turntable                     | not carried      |